



DSS (DSA) 22 Design Series Solenoid Control Valve

300 to 600ℓ/min
32 to 35MPa

Features

- ① Long-life operation is ensured by use of the high-performance, renowned SS(SA)-G01 wet solenoid valve as the pilot valve.
- ② High pressure, high capacity
The 04 size can provides up to 300 ℓ/min, while the 06 size delivers up to 600 ℓ/min.
- ③ Low pressure loss
An original flow path design provides wide-ranging low pressure loss and enhanced system circuit efficiency.
- ④ Internal modification of the pilot and drain can be accomplished without removing the valve by simply connecting and disconnecting plugs.
- ⑤ Built-in pilot pressure check valve
When tandem center type valve is used for the internal pilot valve (option), pilot pressure required for switching is self-maintained.

Specifications

Valve Size		04 Size	06 Size	
Valve Model Number		DSS(DSA)-G04-***-R**-22	DSS(DSA)-G06-***-R**-22	
Maximum Working Pressure MPa{kgf/cm ² }	P.A.B. Ports	35{357}	32{326}	
	T Port	Internal Drain Type	16{163}	
		External Drain Type	21{214}	
Maximum Flow Rate R/min		300	600	
Rated Flow Rate R/min		150	300	
Maximum Pilot Pressure MPa{kgf/cm ² }		25{255}	25{255}	
Minimum pilot pressure MPa{kgf/cm ² }	A** (Spring Offset Type)	0.8{8.2}	0.8{8.2}	
	E** (No-spring Detent Type)			
	C** (Spring Center Type)	1.2{12.2}	1.2{12.2}	
	D** (Pressure Center Type)			
	Built-in Pilot Pressure Check Valve Type (For Internal Pilot)			0.45 {4.6} (for *3Z, *4, *7*, *8 pilot pressure generation)
Maximum Changeover Frequency (cycles/minute)		120	120	
Pilot Volume (cm ³)	A** (Spring Offset Type)	8.0	20.0	
	C** (Spring Center Type)	4.0	10.0	
Weight (kg)	A** (Spring Offset Type)	8.7{9.5}	14.5{15.4}	
	E** (No-spring Detent Type)	9.2{10.0}	15.0{15.9}	
	C** (Spring Center Type)			
	D** (Pressure Center Type)	10.5	16.5	
Operating Environment	Dust-resistance/Water-resistance Rank JIS C 0920		DSS: IP64 (Dust-tight, Splash-proof) DSA: IP65 (Dust-tight, Waterjet-proof)	
	Ambient Temperature		-20 to 50°C	
	Operating Fluid	Temperature Range		-20 to 70°C
		Viscosity Range		15 to 300mm ² /s
		Filtration		25 microns or less
Bundled Accessories	Mounting bolt		M6 × 45 (Two) M10 × 50 (Four)	
	Tightening Torque N·m{kgf·cm}		M6 10 to 13{102 to 133} M10 45 to 55{460 to 560}	
		M12 × 60 (Six)	M12 60 to 70{612 to 714}	

- Note) 1. The maximum flow rate of each valve depends on the pressure. For details, see pages E-43 and E-44.
 2. Weight in parentheses is for stroke adjustment type.
 3. Solenoid specifications are the same as those for SS (SA)-G01. For more information, see pages E-3 and E-15.
 4. For mounting bolts, use bolts of 12.9 strength classification or equivalent.

● Handling

- 1 Pilot pressure values show the differential pressure between the pilot port and tank port or drain port. In the case of the pressure center, they show differential pressure between the pilot and drain ports (DR1, DR2).
- 2 The standard configuration is internal pilot and external drain, but other configurations are possible when required. See page E-45 for more information.
- 3 The JIS number on the nameplate indicates the standard internal pilot and external drain. Note therefore that the JIS numbers on page E-43 and E-44 are used

even if the pilot is external and the drain is internal.

- 4 The maximum operating pressure for internal pilot is 25MPa because it is limited by the pilot pressure.
- 5 For the PT mounting type DSS(DSA)-G**-C7**-*22, open cross over with restrictor C7Y is standard.
- 6 When adjustable spool stroke is desired, specify L in the auxiliary symbol position of the model number. Note, however, that this is not available with the pressure center type.
- 7 When using a detent type (E3*), use constant energization in order to securely maintain the switching position.

8 Use of the pressure center type is recommended for large-volume flow control.

9 For the all ports open center type (A3Z, E3Z, C4, D4), PT mounting type (C7X, C7Y, D7X, D7Y), and PAT mounting type, use the type with built-in external pilot pressure check valve.

10 The coil surface temperature increases if this valve is kept continuously energized. Install the valve so there is no chance of it being touched directly by hand.

Valve Model Number	DSS(DSA)-G04	DSS(DSA)-G06
Front Position		
The pilot solenoid valve on the 04 size and the 06 size are mounted in opposite directions. Refer to the middle of the next page for models of the pilot solenoid valve that are mounted.		
Simplified Symbols		
Detailed Symbols		
Flow Regulator Adjusting Screw Positions	A Port Restrictor: Right side A B Port Restrictor: Left side B	A Port Restrictor: Left side A B Port Restrictor: Right side B
Adjustable Stroke Adjusting Screw Positions	<p>A Port Side: P→A, B→T flow rate adjustment (For C7Y, P→B, A→T)</p> <p>B Port Side: P→B, A→T flow rate adjustment (For C7Y, P→A, B→T)</p>	

Explanation of model No.

DSS - G 06 - C 7 Y C - **R* - C2 - 22

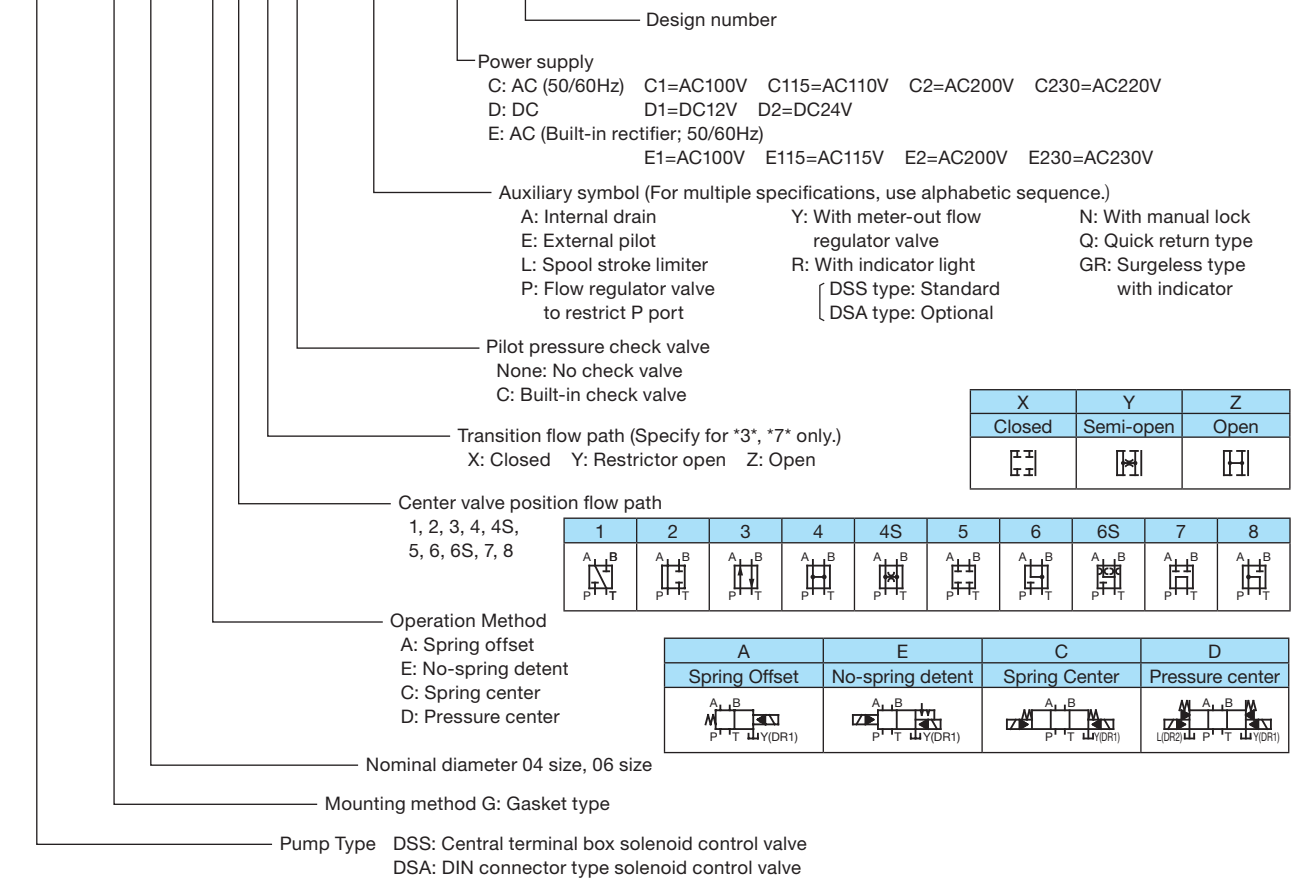

Pilot (PP), Drain (DR)

***High Pilot Pressure**
Use at pressures that do not exceed 25MPa[255kgf/cm²]
*Internal PP, external DR are Nachi-Fujikoshi standards.
For external PP: Built-in stopper plug (Option E)
For internal DR: Stopper plug modification (Option A)
*Internal DR Precautions
Make sure that the differential pressure between the pilot pressure and tank back pressure is greater than the minimum pilot pressure. Do not connect any pipe that generates sudden surge pressure.

Built-in Pilot Solenoid Valve

Valve Model Number	For G04	For G06
DSS(DSA)-G**-A**	SS(SA)-G01-A3X	SS(SA)-G01-H3X
DSS(DSA)-G**-E**	SS(SA)-G01-E3X	
DSS(DSA)-G**-C**	SS(SA)-G01-C6	
DSS(DSA)-G**-D**	SS(SA)-G01-C9	

Built-in Pilot Pressure Check Valve

*Like the C7Y, this internal PP type is used in a flow path configuration where maintenance of pilot pressure is required.

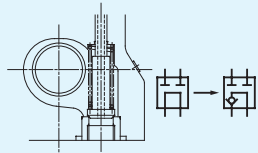

Check Valve Pressure Loss

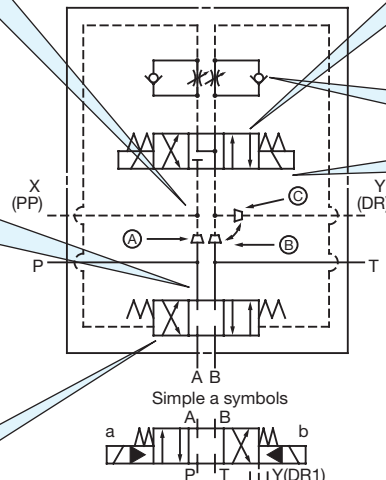
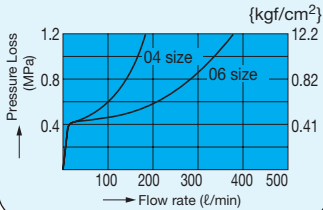

Flow Regulator Valve

*Rotating the adjusting screw clockwise (rightward) slows the main spool switching speed.
P: Excitation of the solenoid (starting of the actuator) causes a restrictor effect.
Y: The restrictor effect can be obtained especially when the solenoid is de-excited (actuator stopped).

Pilot Valve Mounting Bolts

Standard	M5×45 (four)
Stage 1	M5×85 (four)
Stage 2	M5×125 (four)
Stage 3	M5×165 (four)

(Tightening Torque: 5 to 7N·m [51 to 71kgf-cm])

Detent Type Installation

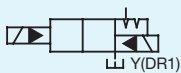

*Install the valve in a horizontal configuration.
*Provide constant energization for secure holding.

Adjustable Stroke Type

*Tightening the adjusting screw makes the main spool stroke smaller, which restricts flow.

Pressure center

*Use this valve in a high-pressure, large-volume circuit to ensure reliable return of the main spool to the neutral position.

Sub Plate Number

Size	Model No.	Connecting Pipe Diameter	Weight (kgf)
For G04	MDS-04-10	Rc 1/2	4.5
	MDS-04X-10	Rc 3/4	
For G06	MDS-06-30	Rc 3/4	5.2
	MDS-06X-30	Rc1	

DSS(DSA)-G04-A**-R**-22
(Spring Offset Type)

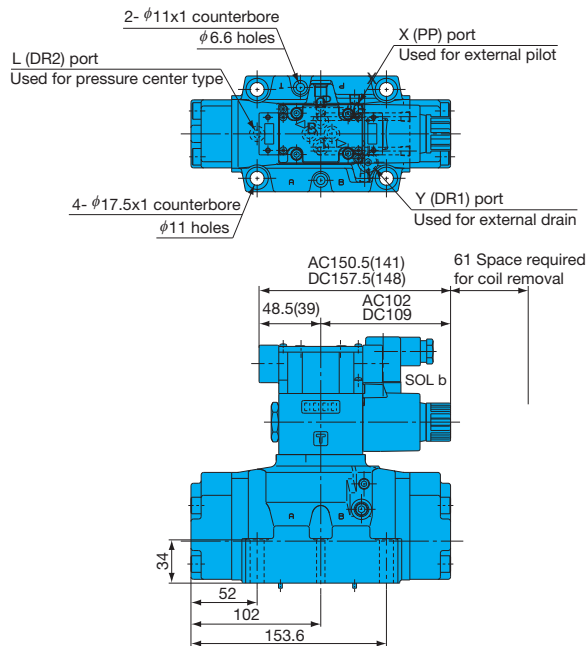

DSS(DSA)-G04-E**-R**-22
C
(No-spring Detent Type)
(Spring Center Type)

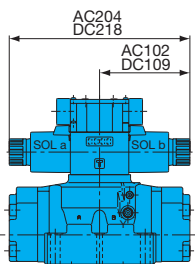

DSS(DSA)-G04-D**-R**-22
(Pressure Center Type)

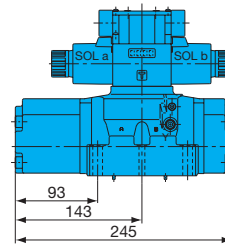

DSS(DSA)-G04-A**-R**-22
E
C
D
(Flow Regulator Type)

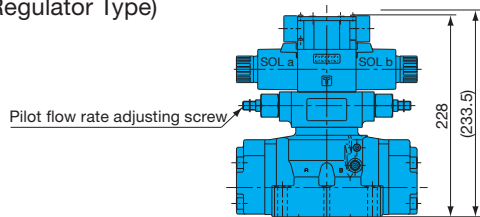

DSS(DSA)-G04-E**-LR**-22
A
C
(Adjustable Stroke Type)

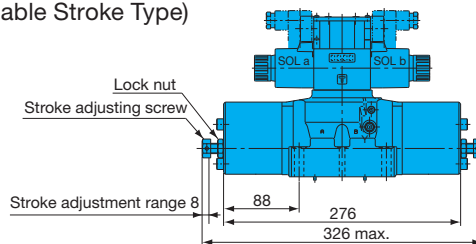

Dimensions in the parentheses are for the DSA-G04-**-RY**-22.

Gasket Surface Dimensions

(ISO 4401-07-06-0-94
JIS B 8355 D-07-06-0-94)

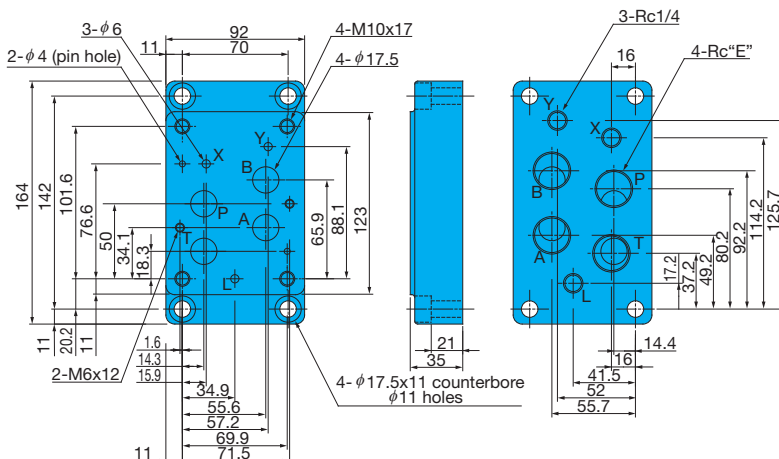

For sub plate DSS (DSA) -G04

Model No.	E	Weight
MDS-04-10	1/2	4.5kg
MDS-04X-10	3/4	

DSS(DSA)-G06-A**-R**-22
(Spring Offset Type)

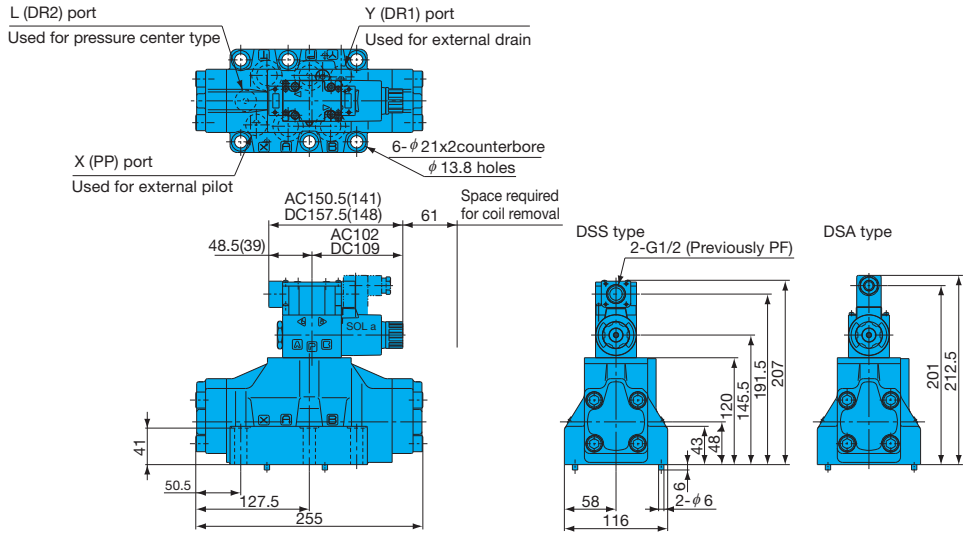

DSS(DSA)-G06-^E/_C** -R**-22
(No-spring Detent Type)
(Spring Center Type)

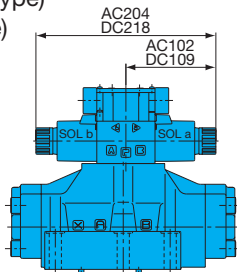

DSS(DSA)-G06-D**-R**-22
(Pressure Center Type)

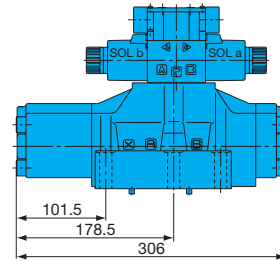

DSS(DSA)-G06-^A/_C/_D** -RY**-22
(Flow Regulator Type)

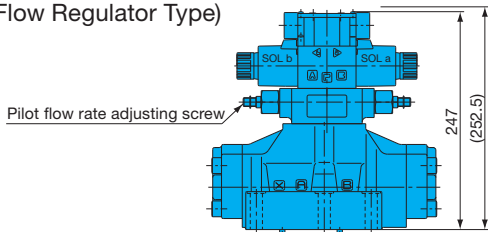

DSS(DSA)-G06-^A/_C** -LR**-22
(Adjustable Stroke Type)

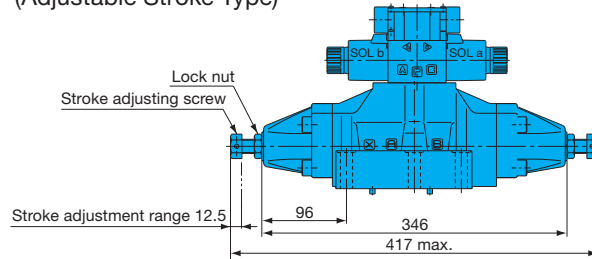

Dimensions in the parentheses are for the DSA-G06-***-RY**-21.

Gasket Surface Dimensions

(ISO 4401-08-07-0-94
(JIS B 8355 D-08-07-0-94))

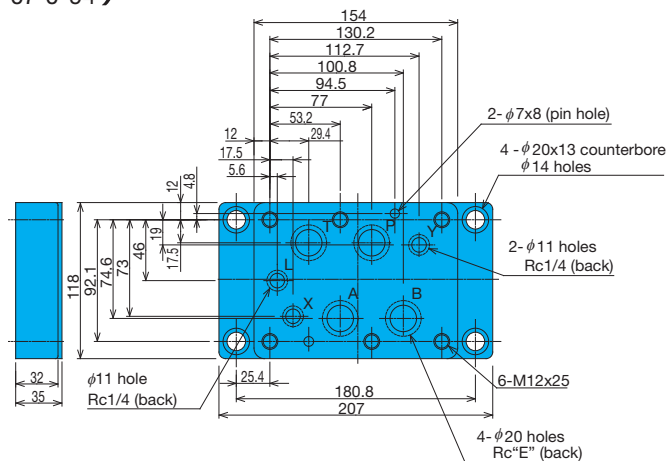

For sub plate DSS (DSA) -G06

Model No.	E	Weight
MDS-06-30	3/4	5.2kg
MDS-06X-30	1	

Performance Curves

Hydraulic Operating Fluid Viscosity 32mm²/s

DSS(DSA)-G04

Model No.	JIS Symbol	Pressure - Flow Rate Allowable Value	Model No.	JIS Symbol	Pressure - Flow Rate Allowable Value		
2-Position Spring Offset Type	DSS(DSA) -G04 -A3X-		2-Position No-spring Detent Type	DSS(DSA) -G04 -E3X-			
	-A3Z-			-E3Z-			
	-A3Y-			-E3Y-			
3-Position Spring Center Type	DSS(DSA) -G04 -C1-	<p>PP-0.8MPa{8.2kgf/cm²}</p> <p>PP-1.2MPa{12.2kgf/cm²}</p>	3-Position Pressure Center Type	DSS(DSA) -G04 -D1-			
	-C2-					-D2-	
	-C5-					-D5-	
	-C6-			-D6-			
	-C6S-			-D6S-			
	-C4S-			-D4S-			
	-C4-			-D4-			
	-C8-			-D8-			
	-C7X-			-D7X-			
-C7Y-		-D7Y-					

Note) The JIS number indicates the standard internal pilot and external drain.

Pressure Loss Characteristics

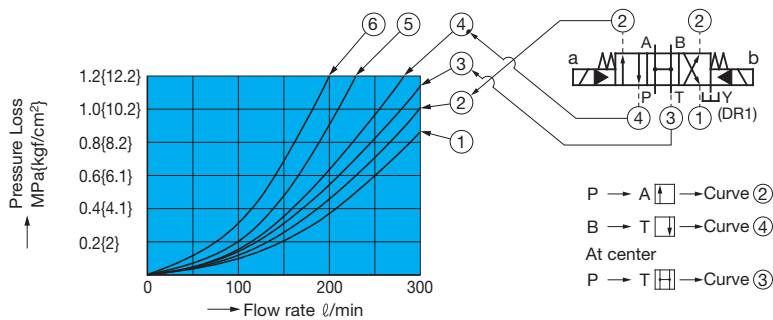

Switching Response Time

Model No. : DSS-G04-C5
Voltage Symbol: C1 (AC Solenoid)

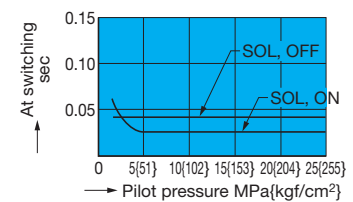

Model No.	JIS Symbol	Pressure - Flow Rate Allowable Value	Model No.	JIS Symbol	Pressure - Flow Rate Allowable Value
2-Position Spring Offset Type					
DSS(DSA) -G06 -A3X-		 Flow rate ℓ/min vs Pressure MPa(kgf/cm²)	DSS(DSA) -G06 -E3X-		 Flow rate ℓ/min vs Pressure MPa(kgf/cm²)
-A3Z-			-E3Z-		
-A3Y-			-E3Y-		
3-Position Spring Center Type					
DSS(DSA) -G06 -C1-		 Flow rate ℓ/min vs Pressure MPa(kgf/cm²)	DSS(DSA) -G06 -D1-		 Flow rate ℓ/min vs Pressure MPa(kgf/cm²)
-C2-			-D2-		
-C5-			-D5-		
-C6-			-D6-		
-C6S-			-D6S-		
-C4S-			-D4S-		
-C4-			-D4-		
-C8-			-D8-		
-C7X- -C7Y-			-D7X- -D7Y-		
3-Position Pressure Center Type					

Note) The JIS number indicates the standard internal pilot and external drain.

Pressure Loss Characteristics

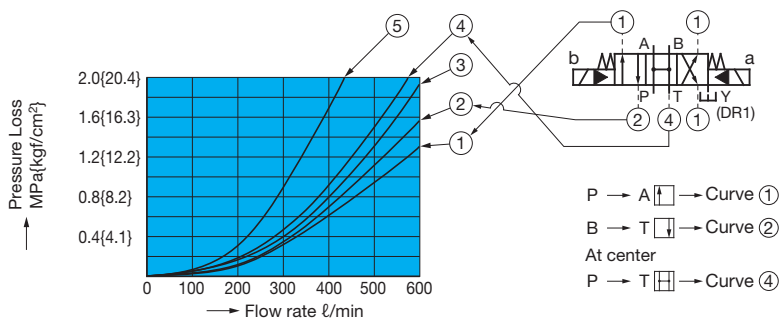

Switching Response Time

Model No. : DSS-G06-C5
Voltage Symbol: C1 (AC Solenoid)

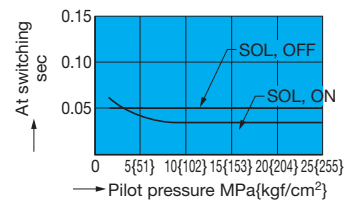

Cross-sectional Drawings

DSS(DSA)-G04-C**-R-C*-22

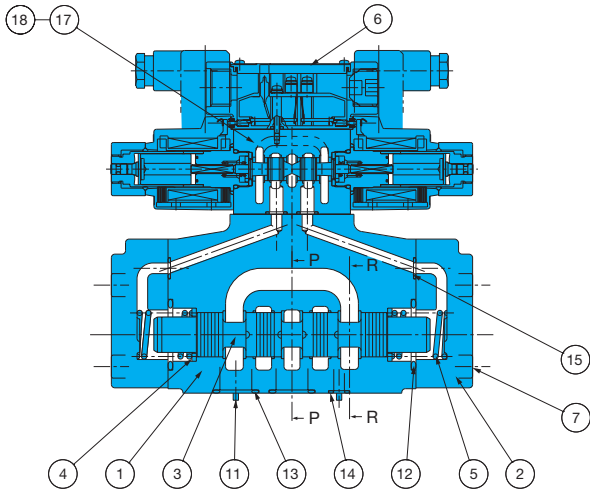

Pilot, Drain System Change

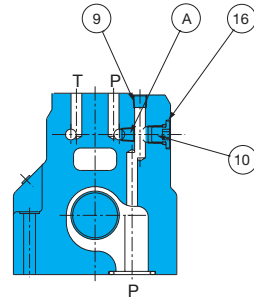

Cross-sectional P-P

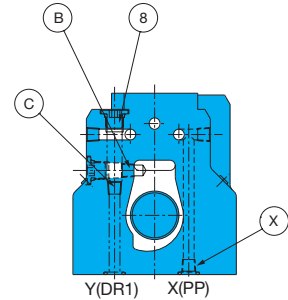

Cross-sectional R-R

DSS(DSA)-G06-C**-R-C*-22

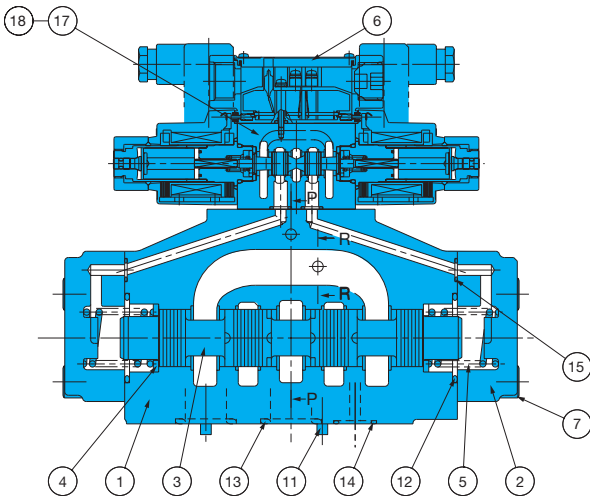

Pilot, Drain System Change

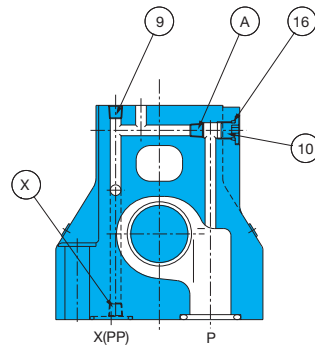

Cross-sectional P-P

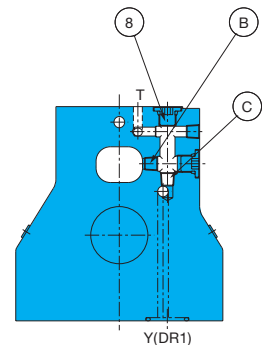

Cross-sectional R-R

Part No.	Part Name	Part No.	Part Name	Part No.	Part Name
1	Body	8	Plug	14	O-ring
2	Cover	9	Plug	15	O-ring
3	Spool	10	Plug	16	O-ring
4	Ring	11	Pin	17	Solenoid Valves
5	Spring	12	O-ring	18	Screw
6	Nameplate	13	O-ring		
7	Screw				

Changing the Pilot and Drain Connections

		After Change	Hexagon Socket Head Plug
Pilot	Internal		Switch from (A) to (X).
	External		Switch from (X) to (A).
Drain	Internal		Switch from (B) to (C).
	External		Switch from (C) to (B).

List of Sealing Parts

Part No.	Part Name	Part Number		Q'ty
		04 size	06 Size	
12	O-ring	NBR-90 P34	NBR-90 G45	2
13	O-ring	NBR-90 P22	NBR-90 P28	4
14	O-ring	NBR-90 P10A	NBR-90 P20	2
15	O-ring	NBR-90 P9	NBR-90 P10	2
16	O-ring	NBR-90 P8	NBR-90 P8	3

Seal Kit Number

04 size		06 Size	
Single Solenoid	Double Solenoid	Single Solenoid	Double Solenoid
EDBS-04AA-1A	EDBS-04CA-1A	EDBS-06AA-1A	EDBS-06CA-1A

Note) The seal kit includes a seal for the pilot solenoid valve.

Note) 1. The materials and hardness of the O-ring conforms with JIS B2401.
2. See SS/SA-G01-**-31 for information about the seal part for the pilot solenoid valve.