

MAKING MODERN LIVING POSSIBLE



Technical Information

Series T90

Axial Piston Pumps



Technical Information Series T90 Axial Piston Pumps

Contents

General Description	Series T90 Family of Pumps	3
	Design	4
	Pictorial Circuit Diagram	5
	System schematic.....	5
Technical Specifications	Features	6
	Operating Parameters	6
	Fluid Specifications.....	7
Operating Parameters	Overview	8
	Input Speed.....	8
	System Pressure	8
	Case Pressure	8
	Fluid Selection.....	9
	Temperature and Viscosity.....	9
System Design Parameters	Filtration System	10
	Reservoir.....	10
	Case Drain	10
	Sizing Equations	11
	SI units	11
	US units	11
	Shaft Loads	12
Features	Shaft Availability and Torque Ratings	13
	Filtration.....	13
	Suction filtration.....	13
	Multi-Function Valves	13
	Charge Pump	14
Control	Manual Displacement Control (MDC).....	15
	Operation.....	15
	Features and Benefits	15
	External Control Handle Requirements.....	16
Installation Drawings	Frame Size 055.....	17
	Frame Size 075.....	18
	Frame Size 100.....	19

General Description

History of Revisions

Table of Revisions

Date	Page	Changed	Rev.
February 2012		First Edition	AA
September 2014		Second Edition	BA

Series T90 Family of Pumps

Danfoss provides **Series T90** as an advanced type of axial piston variable displacement pumps for concret mixers, the development of which is based on more than 30 years of our experience in applying our products in the global market. The new T90 axial piston variable displacement pumps are derived from the sophisticated earlier type of S90 pumps, and are suitable for extended concrete mixer applications.

Series T90 variable displacement pumps are compact, high power density units. All models utilize the parallel axial piston/slipper concept in conjunction with a tiltable swashplate to vary the pump's displacement. Reversing the angle of the swashplate reverses the flow of oil from the pump and thus reverses the direction of rotation of the motor output.

Series T90 pumps include an integral charge pump which is manually controlled to provide system replenishing and cooling oil flow, as well as control fluid flow.

- Series T90 axial piston pumps are designed with the most advanced technology
- With optional sizes 055, 075, 100
- Installation: SAE standard flange
- Axial piston design of high efficiency
- Proved reliability and excellent performance
- Compact, light weight
- Worldwide sales and services
- Metric standard threads for main ports (A and B)

Technical Information Series T90 Axial Piston Pumps

General Description

Design

Series T90 pump cross-section

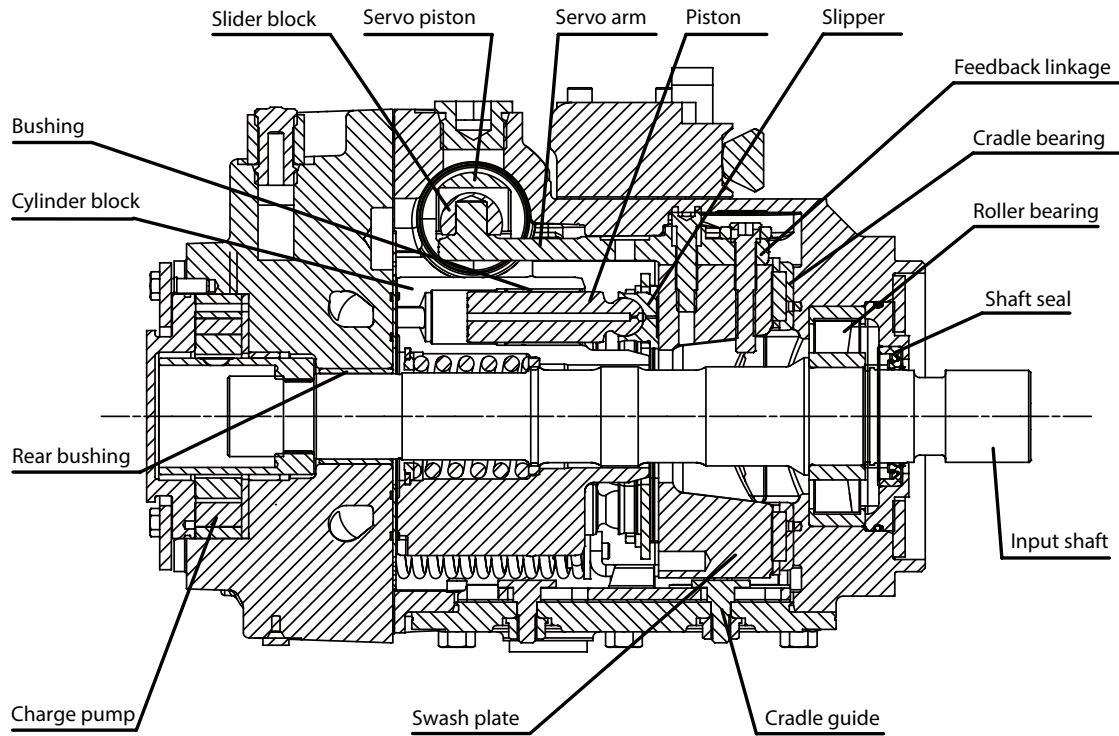

Technical Information Series T90 Axial Piston Pumps

General Description

Pictorial Circuit Diagram

This configuration shows a hydrostatic transmission using a Series T90 axial piston variable displacement pump and a Series 90 fixed displacement motor.

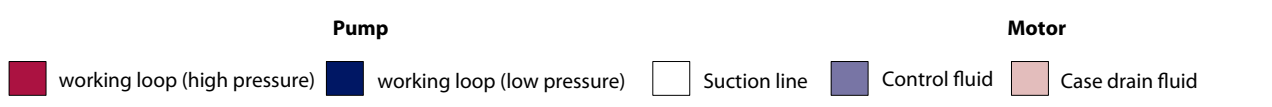
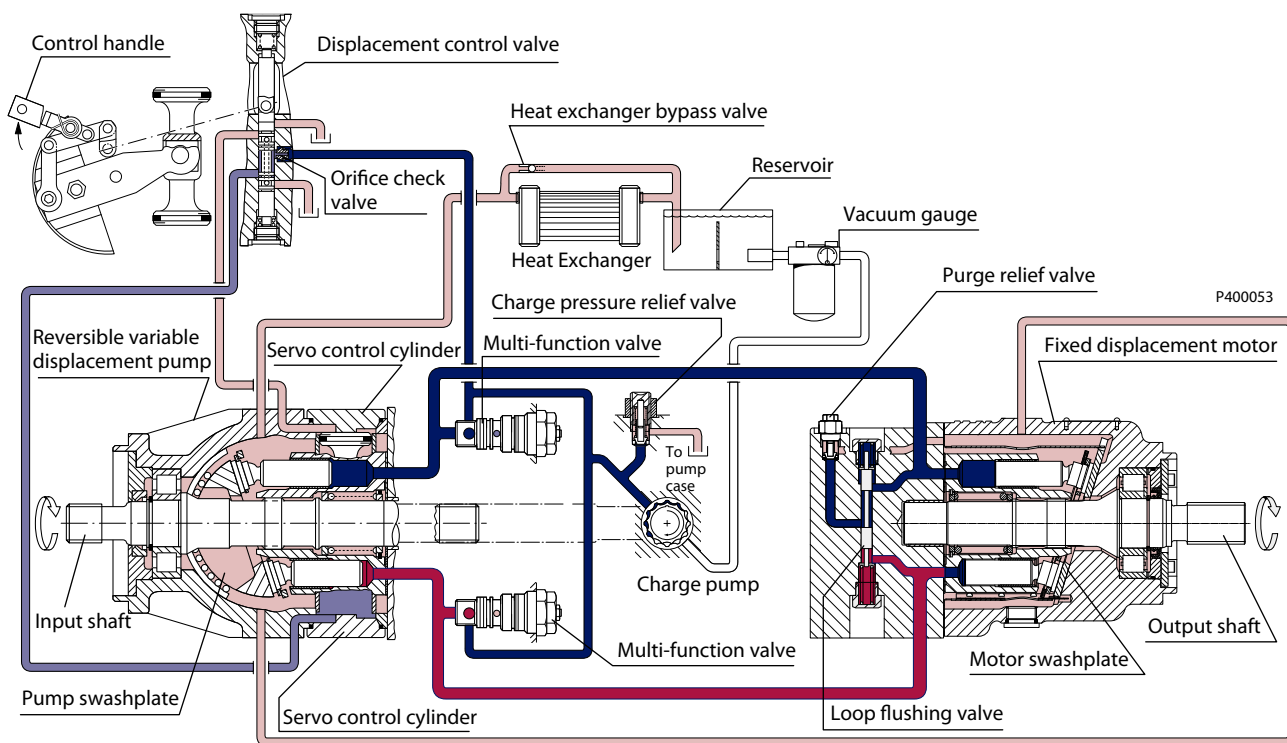

System Schematic

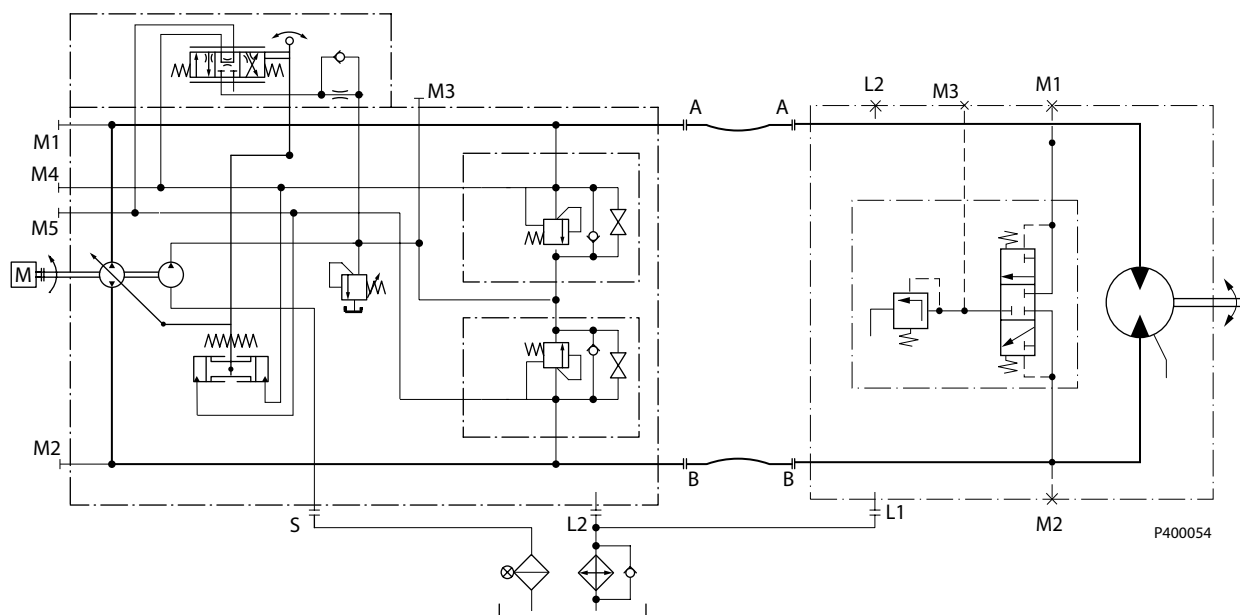

Technical Information Series T90 Axial Piston Pumps

Technical Specifications

Features

Feature	Unit	055	075	100
Displacement	cm ³ [in ³]	55 [3.35]	75 [4.59]	100 [6.10]
Flow at rated speed (theoretical)	l/min [US gal/min]	215 [57]	236 [62]	300 [79]
Torque at maximum displacement (theoretical)	N•m/bar [lbf-in/1000 psi]	0.88 [530]	1.19 [730]	1.59 [970]
Mass moment of inertia of rotating components	kg•m ² [slug•ft ²]	0.0060 [0.0044]	0.0100 [0.0074]	0.0171 [0.0126]
Weight (with control opt. MA)	kg [lb]	40 [88]	49 [108]	68 [150]
Mounting (per SAE J744)		Flange SAE C		
Rotation		Right hand or Left hand rotation		
Main ports: 4-bolts split-flange (per ISO 6162)	mm [in]	25.4 [1.0]	25.4 [1.0]	25.4 [1.0]
Main port configuration		Twin Ports		
Case drain ports (SAE O-ring boss)	UNF thread (in.)	1.0625–12	1.0625–12	1.0625–12
Other ports		SAE O-ring boss		
Input Shafts		Splined, 21 teeth	Splined, 23 teeth	Splined, 23 teeth

Operating Parameters

Parameters	Unit	055	075	100
Input speed				
Minimum	min ⁻¹ (rpm)	400	400	400
Rated		3900	3150	3000
Maximum		4250	3350	3200
System pressure				
Continuous	bar [psi]	400 [5800]		
Maximum		420 [6090]		
Minimum low loop pressure		10 [650]		
Suction port pressure (charge pump inlet)				
Minimum	bar (abs)	0.7 [9]		
Minimum(cold start)	[in. Hg vac.]	0.2 [24]		
Case pressure				
Continuous	bar [psi]	3.0 [44]		
Maximum(cold start)		5.0 [73]		

Technical Information Series T90 Axial Piston Pumps

Technical Specifications
Fluid Specifications

Viscosity mm²/sec (cSt) [SUS]	
Minimum	7 [49]
Recommended range	12-80 [70-370]
Maximum	1600 [7500]
Temperature range °C [°F]	
Minimum	-40 [-40]
Rated	104 [220]
Maximum intermittent	115 [240]
Filtration	
Cleanliness	22/18/13 or higher standard ISO 4406
Efficiency (suction line filtration)	$\beta_{35-45}=75$ ($\beta_{10} \geq 2$)

Operating Parameters

Overview

This section defines the operating parameters and limitations for Series T90 pumps with regard to input speeds and pressures. For actual parameters, refer to the Operating parameters for each displacement on page 7.

Input Speed

Minimum speed is the lowest input speed recommended during engine idle condition. Operating below minimum speed limits the pump's ability to maintain adequate flow for lubrication and power transmission.

Rated speed is the highest input speed recommended at full power condition. Operating at or below this speed should yield satisfactory product life.

Maximum speed is the highest operating speed permitted. Exceeding maximum speed reduces product life and can cause loss of hydrostatic power and braking capacity. Never exceed the maximum speed limit under any operating conditions.

System Pressure

System pressure is the differential pressure between high pressure system ports. It is the dominant operating variable affecting hydraulic unit life. High system pressure, which results from high load, reduces expected life. Hydraulic unit life depends on the speed and normal operating, or weighted average, pressure that can only be determined from a duty cycle analysis.

Application pressure is the high pressure relief or pressure limiter setting normally defined within the order code of the pump. This is the applied system pressure at which the drive-line generates the maximum calculated pull or torque in the application.

Maximum working pressure is the highest recommended Application pressure. Maximum working pressure is not intended to be a continuous pressure. Propel systems with application pressures at, or below, this pressure should yield satisfactory unit life given proper component sizing.

Maximum pressure is the highest allowable Application pressure under any circumstance. Application pressures above maximum working Pressure will only be considered with duty cycle analysis and factory approval.

Pressure spikes are normal and must be considered when reviewing maximum working pressure.

Minimum low loop pressure must be maintained under all operating conditions to avoid cavitation.

All pressure limits are differential pressures referenced to low loop (charge) pressure. Subtract low loop pressure from gauge readings to compute the differential.

Case Pressure

Under normal operating conditions, the rated case pressure must not be exceeded 3 bar (44 psi). During cold start case pressure must be kept below maximum intermittent case pressure 5 bar (73 psi). Size drain plumbing accordingly.

Operating Parameters

⚠ Caution

Possible component damage or leakage

Operation with case pressure in excess of stated limits may damage seals, gaskets, and/or housings, causing external leakage. Performance may also be affected since charge and system pressure are additive to case pressure.

Fluid Selection

Ratings and performance data are based on operating with hydraulic fluids containing oxidation, rust and foam inhibitors. These fluids must possess good thermal and hydrolytic stability to prevent wear, erosion, and corrosion of motor components. Never mix hydraulic fluids of different types.

Fire resistant fluids are also suitable at modified operating conditions. Please see *Hydraulic Fluids and Lubricants Technical Information*, **520L0465**, for more information.

The following hydraulic fluids are suitable:

- Hydraulic Oil DIN 51 524-2 - HLP
- Hydraulic Oil DIN 51 524-3 - HVLP
- SAE J183 API CD, CE and CF

Temperature and Viscosity

The high temperature limits apply at the hottest point in the transmission, which is normally the motor case drain. The system should generally be run at or below the quoted **rated temperature**. The **maximum intermittent temperature** is based on material properties and should never be exceeded.

Cold oil will generally not affect the durability of the transmission components, but it may affect the ability of oil to flow and transmit power; therefore temperatures should remain 16 °C [30 °F] above the pour point of the hydraulic fluid. The **minimum temperature** relates to the physical properties of component materials. Size heat exchangers to keep the fluid within these limits. Danfoss recommends testing to verify that these temperature limits are not exceeded.

For maximum efficiency and bearing life, ensure the fluid viscosity remains in the **recommended range**. The **minimum viscosity** should be encountered only during brief occasions of maximum ambient temperature and severe duty cycle operation. The **maximum viscosity** should be encountered only at cold start.

System Design Parameters

Filtration System

To prevent premature wear, ensure only clean fluid enters the hydrostatic transmission circuit. A filter capable of controlling the fluid cleanliness to ISO 4406 class 22/18/13 (SAE J1165) or better, under normal operating conditions, is recommended. These cleanliness levels can not be applied for hydraulic fluid residing in the component housing/case or any other cavity after transport.

The selection of a filter depends on a number of factors including the contaminant ingress rate, the generation of contaminants in the system, the required fluid cleanliness, and the desired maintenance interval. Filters are selected to meet the above requirements using rating parameters of efficiency and capacity.

Filter efficiency can be measured with a Beta ratio¹ (β_X). For simple suction-filtered closed circuit transmissions and open circuit transmissions with return line filtration, a filter with a β -ratio within the range of $\beta_{35-45} = 75$ ($\beta_{10} \geq 2$) or better has been found to be satisfactory.

Because each system is unique, only a thorough testing and evaluation program can fully validate the filtration system. Please see *Design Guidelines for Hydraulic Fluid Cleanliness Technical Information*, **520L0467** for more information.

Reservoir

The hydrostatic system reservoir should accommodate maximum volume changes during all system operating modes and promote de-aeration of the fluid as it passes through the tank. A suggested minimum total reservoir volume is 5/8 of the maximum charge pump flow per minute with a minimum fluid volume equal to 1/2 of the maximum charge pump flow per minute. This allows 30 seconds fluid dwell for removing entrained air at the maximum return flow. This is usually adequate to allow for a closed reservoir (no breather) in most applications.

Locate the reservoir outlet (charge pump inlet) above the bottom of the reservoir to take advantage of gravity separation and prevent large foreign particles from entering the charge inlet line. Position the reservoir inlet (fluid return) to discharge below the normal fluid level, toward the interior of the tank. A baffle (or baffles) will further promote de-aeration and reduce surging of the fluid.

Case Drain

All single T90 pumps are equipped with multiple drain ports. Port selection and case drain routing must enable the pump housing to maintain a volume of oil not less than half full and normal operating case pressure limits of the unit are maintained. Case drain routing and design must consider unit case pressure ratings.

A case drain line must be connected to one of the case outlets (L1 or L2) to return internal leakage to the system reservoir.

Do not over torque the fitting on case drain port L2 (located on the side cover). The proper torque is 100 N·m [74 lbf·ft] maximum. Over torquing the fitting may change the neutral position of the swashplate.

¹ Filter β_x is a measure of filter efficiency defined by ISO 4572. It is defined as the ratio of the number of particles greater than a given diameter ("x" in microns) upstream of the filter to the number of these particles downstream of the filter.

System Design Parameters
Sizing Equations

The following equations are helpful when sizing hydraulic pumps. Generally, the sizing process is initiated by an evaluation of the machine system to determine the required motor speed and torque to perform the necessary work function. Refer to *Selection of drive line components*, **BLN-9885**, for a more complete description of hydrostatic drive line sizing. First, the motor is sized to transmit the maximum required torque. The pump is then selected as a flow source to achieve the maximum motor speed.

SI Units	Output flow $Q = \frac{V_g \cdot n \cdot \eta_v}{1000}$ (l/min)	$V_g =$ Displacement per revolution (cm ³ /rev)
	Input torque $M = \frac{V_g \cdot \Delta p}{20 \cdot \pi \cdot \eta_m}$ (N·m)	$\Delta p =$ $p_o - p_i$ (system pressure)(bar)
	Input power $P = \frac{M \cdot n \cdot \pi}{30\,000} = \frac{Q \cdot \Delta p}{600 \cdot \eta_t}$ (kW)	$n =$ Speed (min ⁻¹ (rpm))
		$\eta_v =$ Volumetric efficiency
		$\eta_m =$ Mechanical efficiency
		$\eta_t =$ Overall efficiency ($\eta_v \cdot \eta_m$)
US Units	Output flow $Q = \frac{V_g \cdot n \cdot \eta_v}{231}$ (US gal/min)	$V_g =$ Displacement per revolution (in ³ /rev)
	Input torque $M = \frac{V_g \cdot \Delta p}{2 \cdot \pi \cdot \eta_m}$ (lbf·in)	$\Delta p =$ $p_o - p_i$ (system pressure) (psi)
	Input power $P = \frac{M \cdot n \cdot \pi}{198\,000} = \frac{Q \cdot \Delta p}{1714 \cdot \eta_t}$ (hp)	$n =$ Speed (min ⁻¹ (rpm))
		$\eta_v =$ Volumetric efficiency
		$\eta_m =$ Mechanical efficiency
		$\eta_t =$ Overall efficiency ($\eta_v \cdot \eta_m$)

Technical Information Series T90 Axial Piston Pumps

System Design Parameters

Shaft Loads

The table below indicates the bearing life in B_{10} hours. These data are based on the condition where the pump is operated with system pressure at 240bar[3500 psi], input speed at 1800RPM, with max. displacement and no external thrust/radial shaft loads. Nearly equal amounts of forward vs. reverse swashplate operation is experienced. The charge pump is of standard displacement and is a standard charge pressure pump.

T90 piston pumps are designed with bearings that can accept some external radial and thrust loads. The external shaft radial load limits are a function of the load position and orientation, and operating conditions of the motor.

The maximum allowable radial load (Re) is based on the maximum external moment (Me) and the distance (L) from the mounting flange to the load. It may be determined using the following table and formula.

Formula :

$$Re = Me / L$$

All external shaft loads affect bearing life. In applications where external shaft loads cannot be avoided, minimize the impact by positioning the load at 90° or 270° as shown in the figure.

Contact your Danfoss representative for an evaluation of unit bearing life, if

- you have continuously applied external loads exceeding 25 % of the maximum allowable radial load (Re)
- or the pump swashplate is positioned on one side of center all or most of the time.
- bearing life B_{10} is critical.

Use of tapered output shafts or clamp-type couplings is recommended where radial shaft loads are present.

Allowable external shaft load

Parameters	055	075	100
External moment (Me)	101	118	126
N·m [lbf·in]	[893]	[1043]	[1115]
Maximum shaft thrust in (T_{in})	3340	4300	5160
N [lbf]	[750]	[996]	[1160]
Maximum shaft thrust in (T_{out})	910	930	1000
N [lbf]	[204]	[209]	[224]

Shaft life

Parameter	Bearing life - B_{10} hours
55	22 090
75	22 970
100	22 670

Radial/thrust load position

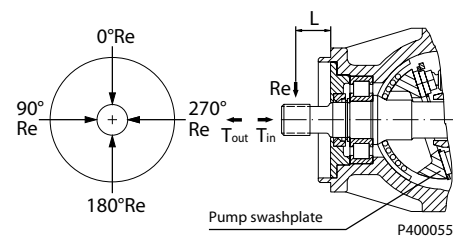

Technical Information Series T90 Axial Piston Pumps

Features

Shaft Availability and Torque Ratings

Shaft availability and torque ratings

Shaft description	055	075	100
21 teeth 16/32 pitch spline	1130 [10 000]	—	—
23 teeth 16/32 pitch spline	—	1580 [14 000]	1580 [14 000]

Filtration

Suction filtration

The suction filtration is placed in the circuit between the reservoir and inlet to the charge pump, as shown below.

Filter with block alarm is recommended

Suction filtration

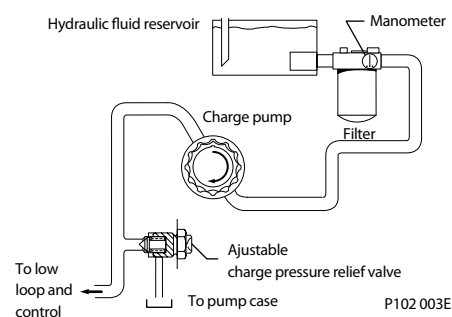

Multi-Function Valves

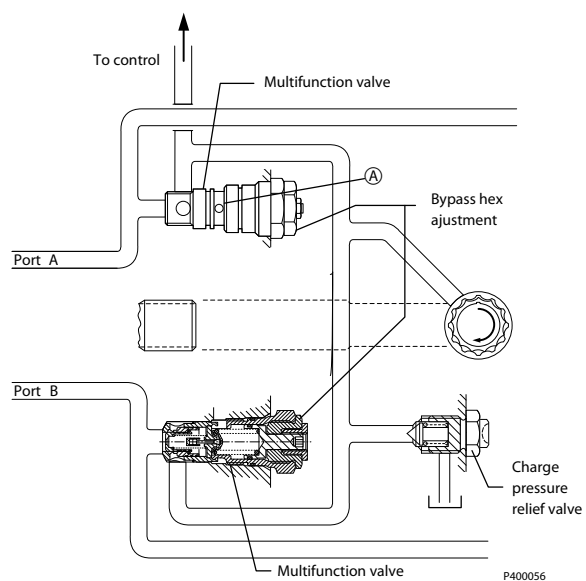
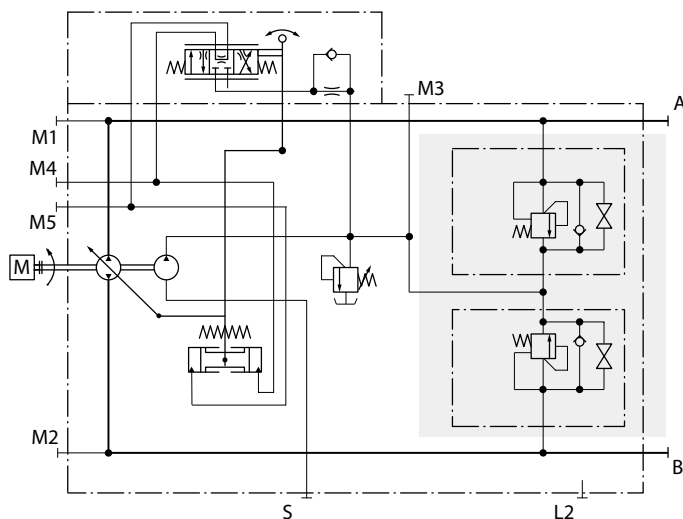

Features**Charge Pump**

Charge flow is required on all Series T90 pumps applied in closed circuit installations. The charge pump provides flow to make up internal leakage, maintain a positive pressure in the main circuit, provide flow for cooling and filtration, replace any leakage losses from external valving or auxiliary systems, and to provide flow and pressure for the control system.

Many factors influence the charge flow requirements and the resulting charge pump size selection. These factors include system pressure, pump speed, pump swashplate angle, type of fluid, temperature, size of heat exchanger, length and size of hydraulic lines, control response characteristics, auxiliary flow requirements, hydrostatic motor type, etc. When initially sizing and selecting hydrostatic units for an application, it is frequently not possible to have all the information necessary to accurately evaluate all aspects of charge pump size selection.

Unusual application conditions may require a more detailed review of charge pump sizing. Charge pressure must be maintained at a specified level under all operating conditions to prevent damage to the transmission. Danfoss recommends testing under actual operating conditions to verify this.

Recommend charge pump sizes and speed limits

Charge pump size cm³ [in³]	Rated speed min⁻¹ (rpm)
20 [1.20]	3600

Control

Manual Displacement Control (MDC)

Operation

The manual displacement control converts a mechanical input signal to a hydraulic signal that tilts the cradle swashplate through an angular rotation varying the pump's displacement from full displacement in one direction to full displacement in the opposite direction.

The manual displacement control has a mechanical feedback mechanism which moves a servo valve in the proper relationship to the input signal and the angular position of the swashplate. The control is designed so that the angular rotation of the swashplate is proportional to the mechanical input signal. The control is designed with an internal override mechanism which allows the mechanical input to be moved at a faster rate than the movement of the swashplate without damage to the control.

Features and benefits of the manual displacement control:

- Precision parts provide repeatable, accurate displacement settings with a given input signal.
- The manual displacement control is a high gain control: With only small movement of the control handle (input signal), the servo valve moves to full open position porting maximum flow to the servo cylinder. This is a high response system with low input force.
- The integral override mechanism allows rapid changes in input signal without damaging the control mechanism.
- The double-acting servo piston is coupled to a spring centering mechanism. The servo control valve is spring centered such that with no input signal the servo valve is open centered and thus no fluid is ported to the servo cylinder.
- Benefits:
 - Pump returns to neutral after prime mover shuts down.
 - Pump returns to neutral if external control linkage fails at the control handle or if there is a loss of charge pressure.

Manual displacement control schematic

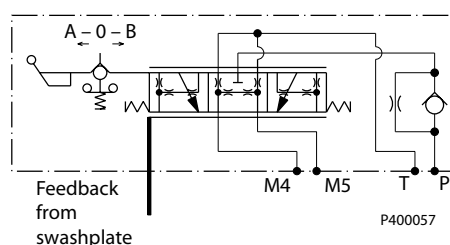

Cross-section

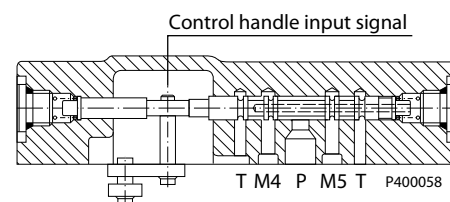

Technical Information Series T90 Axial Piston Pumps

Control

Control

Manual Displacement Control (MDC) (continued)

External control handle requirements

- Torque required to move handle to maximum displacement is 0.68 to 0.9 N·m [6 to 8 lbf·in].
- Torque required to hold handle at given displacement is 0.34 to 0.57 N·m [3 to 5 lbf·in].
- Torque required to overcome the override mechanism is 1.1 to 2.3 N·m [10 to 20 lbf·in] with the maximum torque required for full forward to full reverse movement.
- Maximum allowable input torque is 17 N·m [150 lbf·in].

Pump displacement vs. control lever rotation

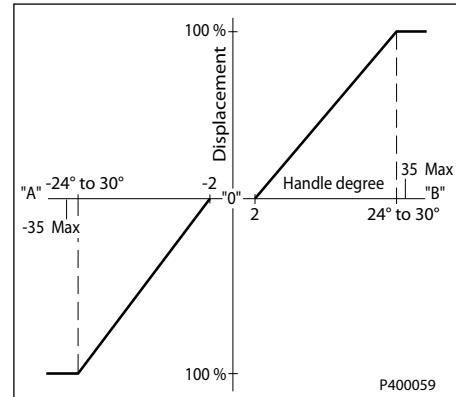

Control lever rotation range

a	0.5° - 4.5°
b	24° - 30°

Volumetric efficiencies of the system will have impacts on the start- and end input commands.

Pump output flow direction and control lever rotation

Input shaft rotation	CW		CCW	
	A CCW	B CW	A CCW	B CW
Port A flow (M1)	Out	In	In	Out
Port B flow (M2)	In	Out	Out	In
Servo cylinder	M5	M4	M5	M4

Refer to *Installation drawings* for handle connection requirements

Control
**High Current Electric Displacement Control (HCEDC)
Option PH and PJ**
Operation

The HCEDC uses two solenoid operated, proportional-pressure reducing valves to control the pilot pressure to a 4-way servo valve, which ports hydraulic pressure to either side of a double acting servo piston. The servo piston tilts the cradle swashplate, thus varying the pump's displacement from full displacement in one direction to full displacement in the opposite direction. Each solenoid valve acts independently for forward or reverse operation; therefore, the electronic controller must be able to accommodate two independent pilot valve signal outputs.

The control has a mechanical feedback mechanism which moves the servo valve in relation to the input signal and the angular position of the swashplate. The electrical displacement control is designed so the angular rotation of the swashplate (pump displacement) is proportional to the electrical input signal. Swashplate position changes due to load variation are sensed by feedback linkage system connected to the swashplate and control valve. This will activate the valve and supply pressure to the servo piston, maintaining the swashplate in its commanded position. The solenoids are equipped with manual override capability thereby allowing the pump to be commanded to maximum angle in either direction. This is done by depressing the plunger on the top of the solenoid. Manual operation of the control override is intended for system troubleshooting only.

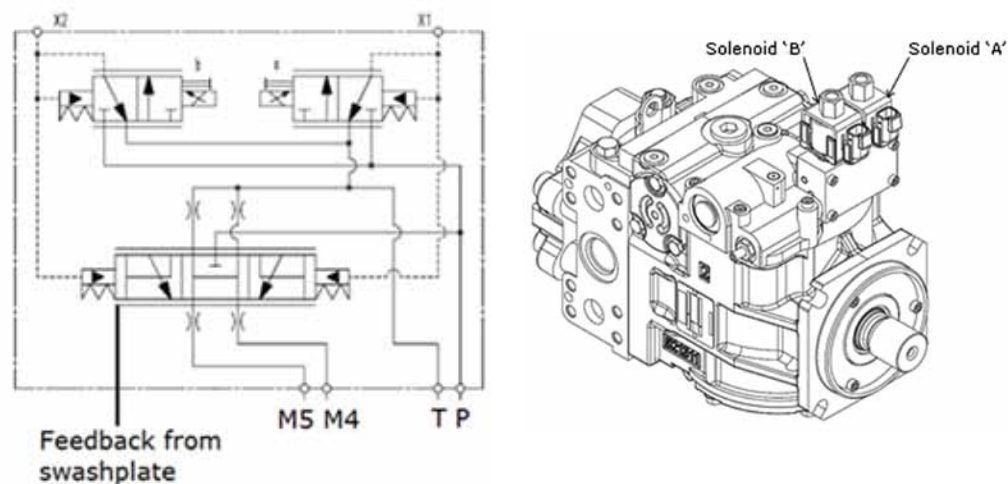
High current electric displacement control schematic

Electric Characteristics

	(CCW) AS SEEN FROM SHAFT		(CW) AS SEEN FROM SHAFT	
	A	B	A	B
Active Solenoid	A	B	A	B
Pressurized port	X1	X2	X1	X2
System port A flow	In	Out (M1)	Out (M1)	In
System port B flow	Out (M2)	In	In	Out (M2)
Servo port active	2 (M5)	1 (M4)	2 (M5)	1 (M4)
Options	PH		PJ	
Starting current "a"	350mA		178mA	
Maximum current "b"	850mA		440mA	

Technical Information Series T90 Axial Piston Pumps

Control

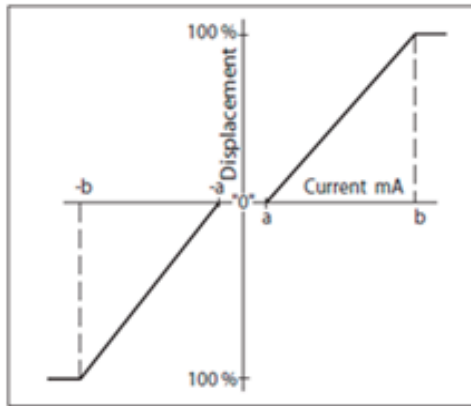
High Current Electric Displacement Control (HCEDC) Option PH and PJ -Continued



	PH	PJ
Maximum current	850mA	440mA
PWM frequency	100 - 200 Hz	
Coil resistance @ 20 °C	9.0 Ω	35.6 Ω

The Option PJ coils have an IP 69 K environmental protection rating. The coils include a uni-directional, polarity diode which protects downstream electronic components from power surges originating from the coil. Therefore, care must be taken to not reverse the “+” and “-” terminals. Failure to do so will damage the diode and render the coil unusable. The coils have a “1” and “2” molded in the connector for proper identification of the poles.

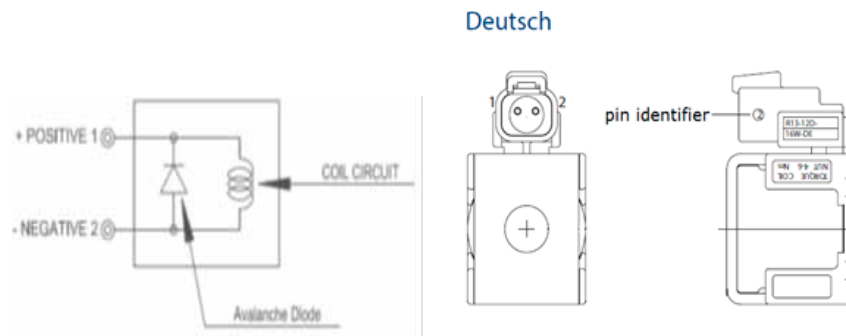

The Option PH (12V) and Option PJ (24V) controls can be distinguished by the color of the shroud. The 24V Option PJ has a yellow shroud while the 12V Option PH has a blue shroud.



Technical Information Series T90 Axial Piston Pumps

Installation Drawings

Size 055

Manual Displacement Control (MDC), endcap twin ports

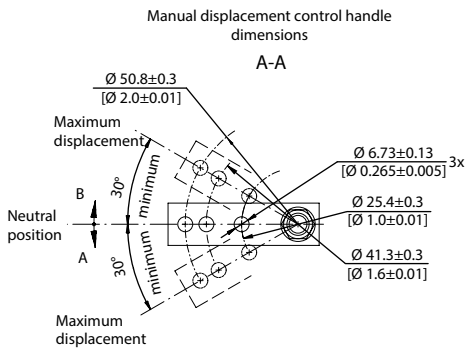
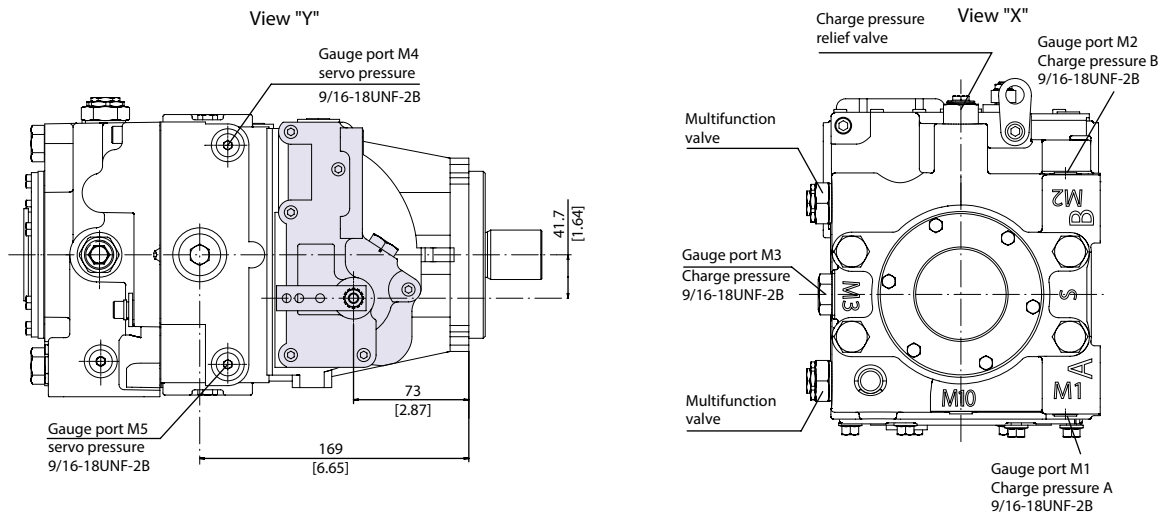
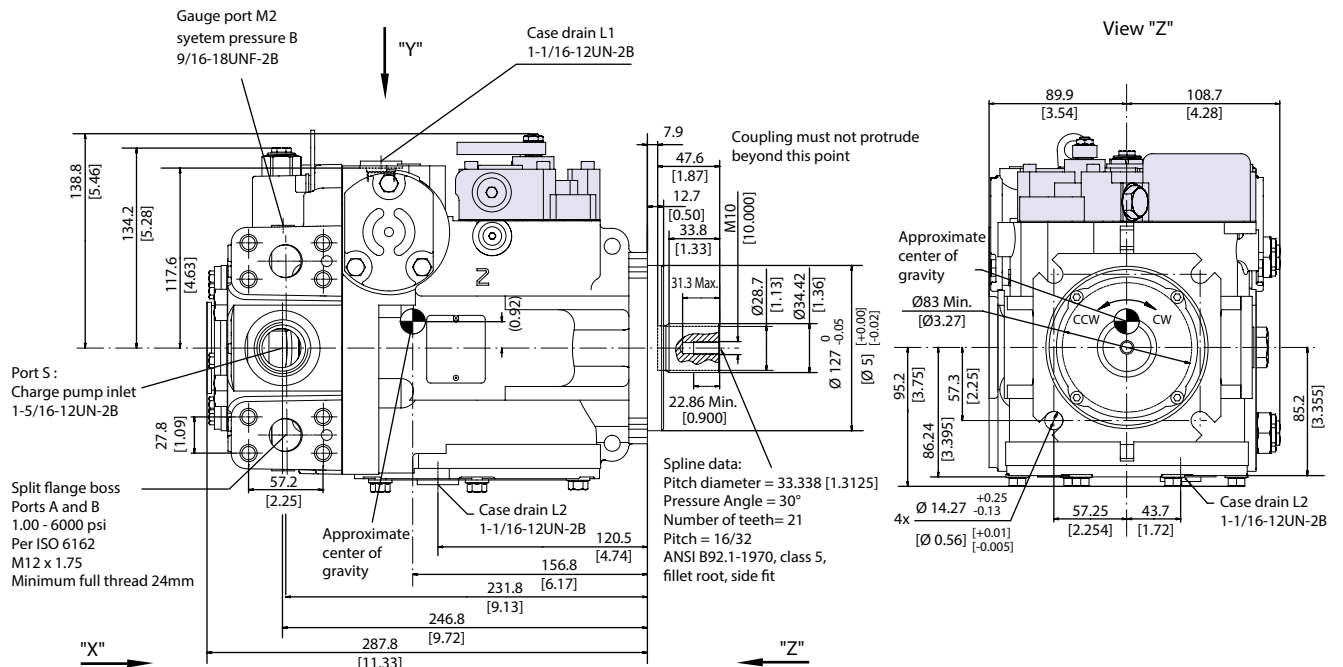

P400060

Technical Information Series T90 Axial Piston Pumps

Control

Size 075

Manual Displacement Control(MDC), endcap twin ports

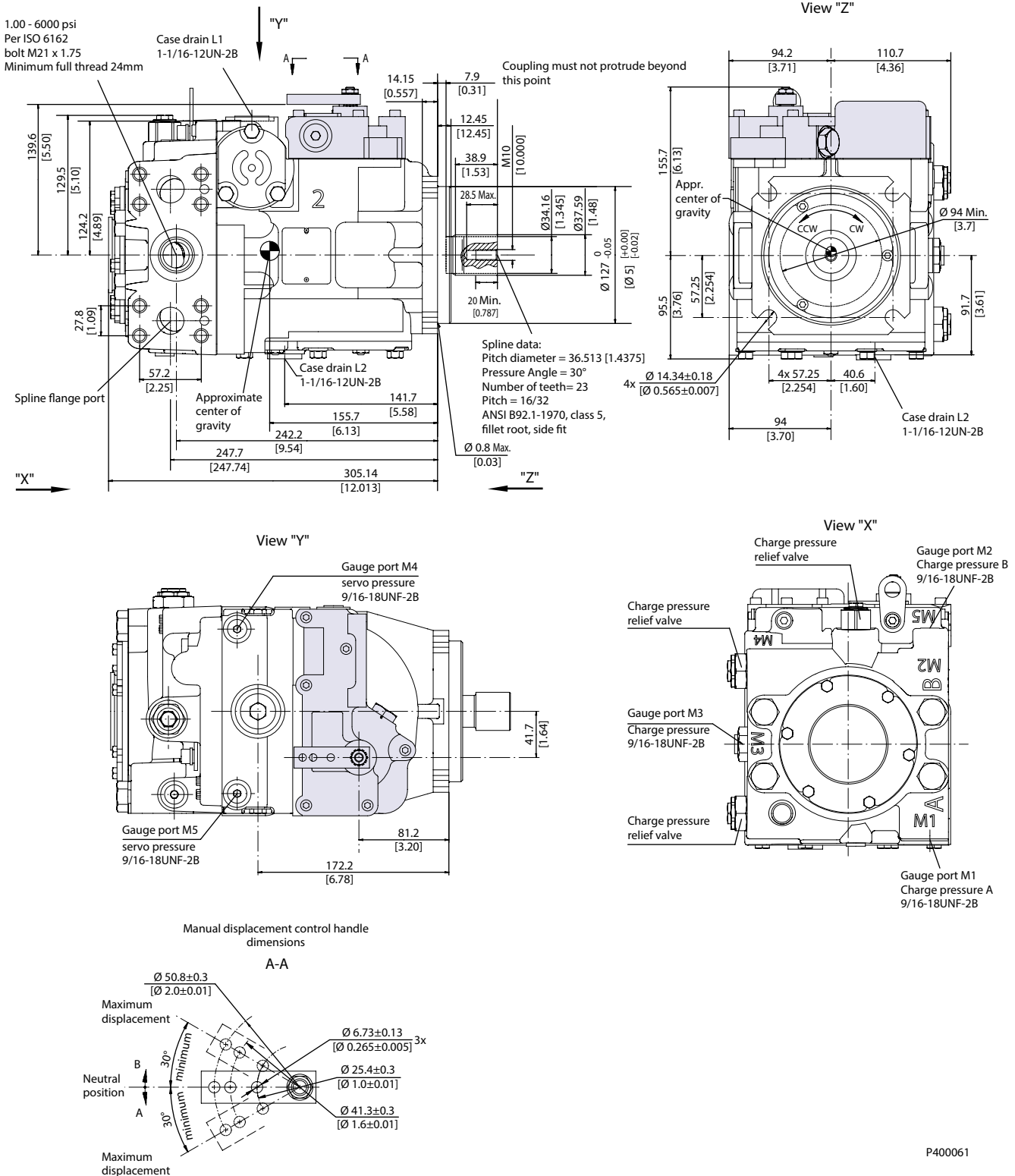

P400061

Technical Information Series T90 Axial Piston Pumps

Installation Drawings

Size 100

Manual displacement control (MDC) endcap twin ports

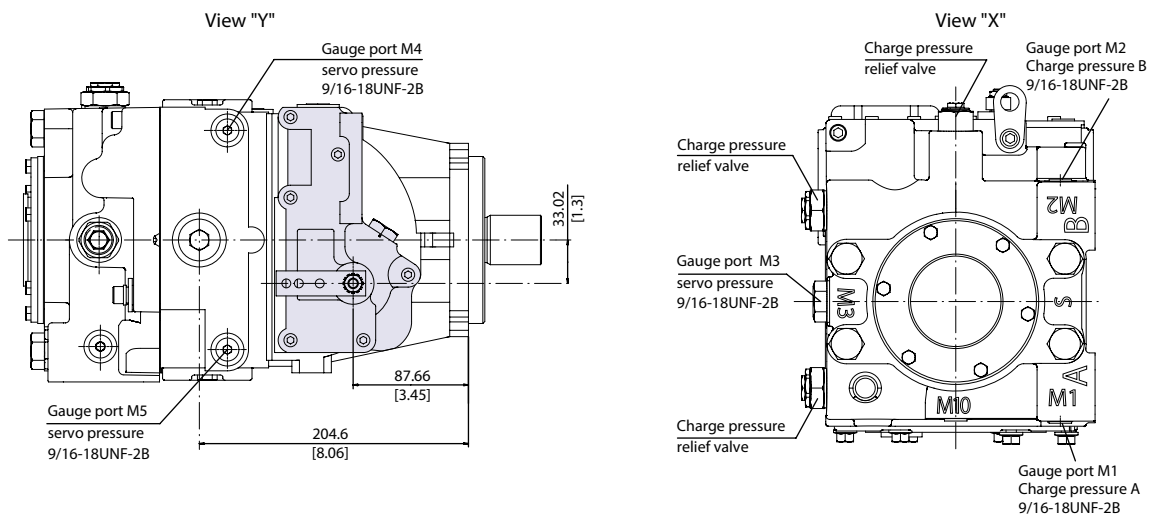
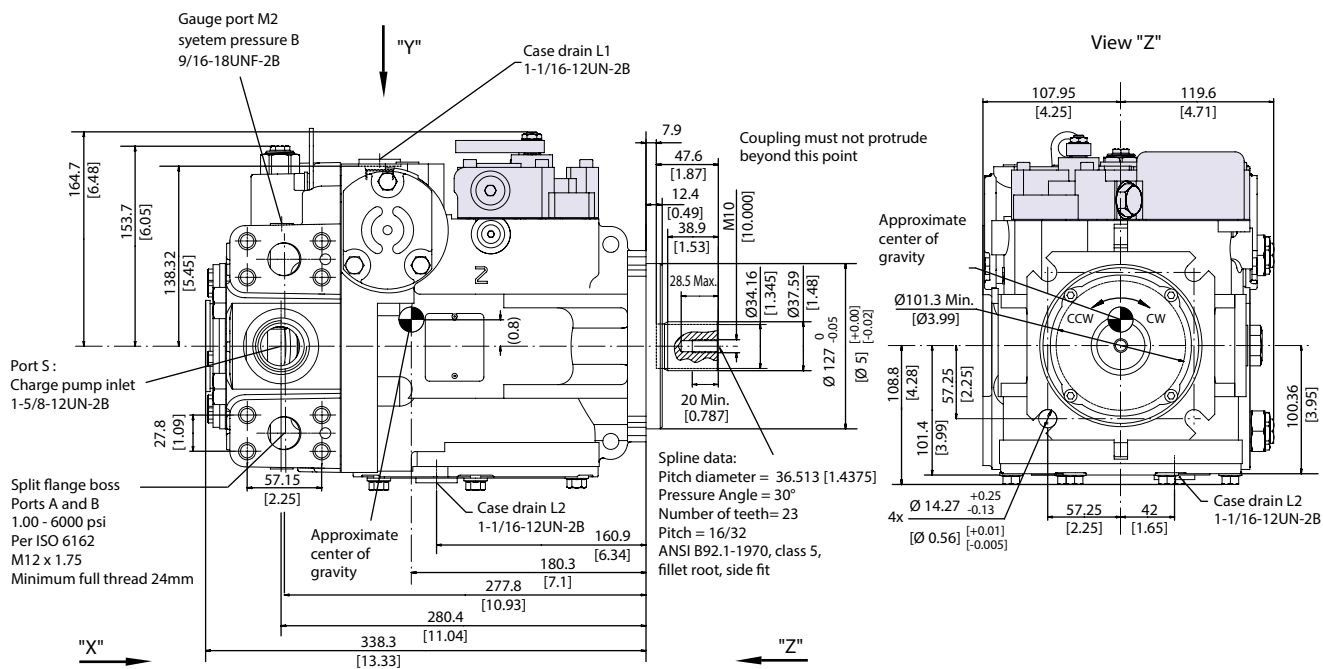

Manual displacement control handle dimensions

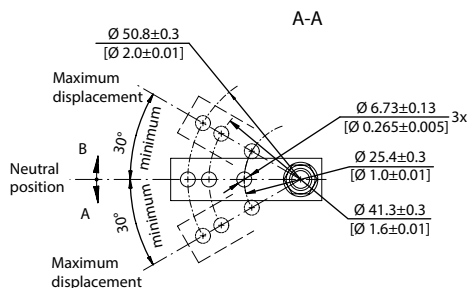

P400062



Products we offer:

- Bent Axis Motors
- Closed Circuit Axial Piston Pumps and Motors
- Displays
- Electrohydraulic Power Steering
- Electrohydraulics
- Hydraulic Power Steering
- Integrated Systems
- Joysticks and Control Handles
- Microcontrollers and Software
- Open Circuit Axial Piston Pumps
- Orbital Motors
- PLUS+1® GUIDE
- Proportional Valves
- Sensors
- Steering
- Transit Mixer Drives

Danfoss Power Solutions is a global manufacturer and supplier of high-quality hydraulic and electronic components. We specialize in providing state-of-the-art technology and solutions that excel in the harsh operating conditions of the mobile off-highway market. Building on our extensive applications expertise, we work closely with our customers to ensure exceptional performance for a broad range of off-highway vehicles.

We help OEMs around the world speed up system development, reduce costs and bring vehicles to market faster.

Danfoss – Your Strongest Partner in Mobile Hydraulics.

Go to www.powersolutions.danfoss.com for further product information.

Wherever off-highway vehicles are at work, so is Danfoss.

We offer expert worldwide support for our customers, ensuring the best possible solutions for outstanding performance. And with an extensive network of Global Service Partners, we also provide comprehensive global service for all of our components.

Please contact the Danfoss Power Solution representative nearest you.

Comatrol

www.comatrol.com

Schwarzmueller-Inverter

www.schwarzmueller-inverter.com

Turolla

www.turollaocg.com

Valmova

www.valmova.com

Hydro-Gear

www.hydro-gear.com

Daikin-Sauer-Danfoss

www.daikin-sauer-danfoss.com

Local address:

Danfoss Power Solutions (US) Company

2800 East 13th Street
Ames, IA 50010, USA
Phone: +1 515 239 6000

Danfoss Power Solutions GmbH & Co. OHG

Krokamp 35
D-24539 Neumünster, Germany
Phone: +49 4321 871 0

Danfoss Power Solutions ApS

Nordborgvej 81
DK-6430 Nordborg, Denmark
Phone: +45 7488 2222

Danfoss Power Solutions (Shanghai) Co. Ltd.

Building #22, No. 1000 Jin Hai Rd
Jin Qiao, Pudong New District
Shanghai, China 201206
Phone: +86 21 3418 5200

Danfoss can accept no responsibility for possible errors in catalogues, brochures and other printed material. Danfoss reserves the right to alter its products without notice. This also applies to products already on order provided that such alterations can be made without consequential changes being necessary in specifications already agreed. All trademarks in this material are property of the respective companies. Danfoss and the Danfoss logotype are trademarks of Danfoss A/S. All rights reserved.